

JOSSOIS®

CATÁLOGO BASES

BASES CATALOG

www.jossois.com

LEGENDA LEGEND



DIÂMETER DA HASTE DO GUARDA-SOL
PARASOL POLE DIAMETER



PESO
WEIGHT



GUARDA-SOL RECOMENDADO
RECOMMENDED PARASOL



OPÇÕES DE COR
COLOUR OPTIONS

BASES BRITADAS | GRANITADAS



REF. 04030005.0007

Base de cimento britado
Crushed cement base

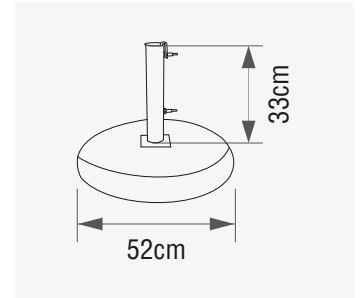
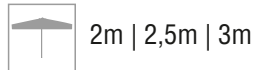

REF. 04030070

Base em granito
Granite base

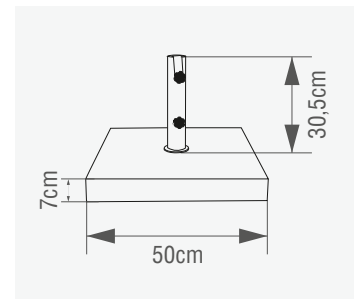
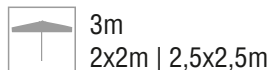
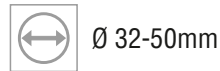

*COM OPÇÃO DE TUBO ZINCADO | ZINCATED TUBE OPTION



REF. 04030085

Base em cimento britado com pegas
Crushed cement base with handles

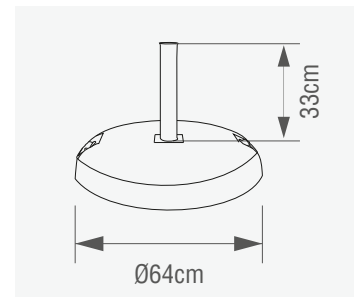
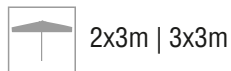

REF. 04030045.0007

Base em cimento britado com pegas e borracha de protecção
Crushed cement base with handles and rubber protection

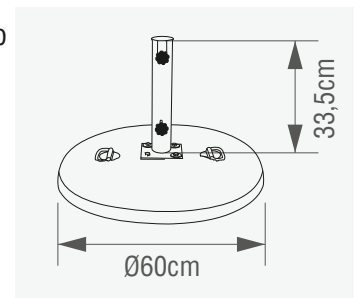
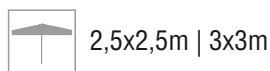

BASES GRANITADAS



REF. 04030045.0004

Base de cimento britado com pegas
Crushed cement base

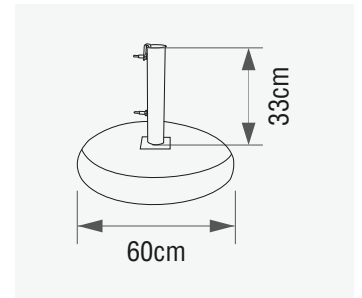
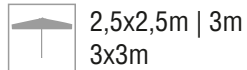

BASES METÁLICAS



REF. 04030065.0003

Base de ferro com tubo articulado
Iron metal base with flexible tube

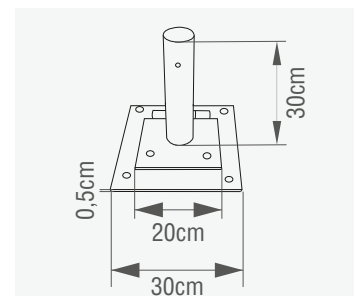
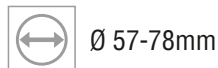

REF. 04030012

Base de embutir em inox
Base to inlay in stainless

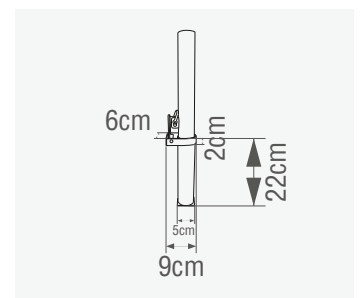
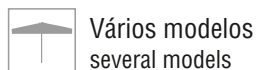

BASES METÁLICAS



REF. 04030024

Base de embutir articulada em ferro heliaço
Base to enlay articulated in iron



17kg



4x4m

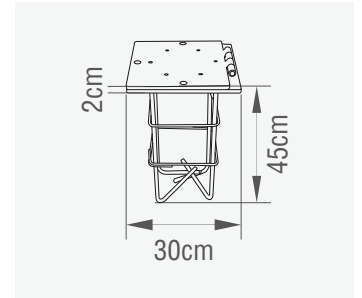

REF. 04030024.0003

Base de embutir em ferro heliaço
Base to enlay in iron



6kg



Vários modelos
Several models

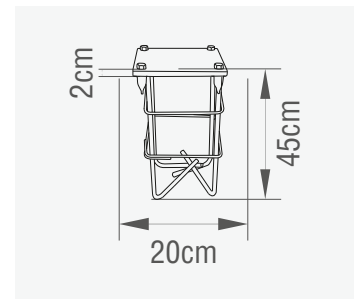

REF. 04030012.0004

Base de embutir em inox
Base to inlay in stainless



Octogonal
60/64mm



5,1kg



Modelo Apple
Apple model

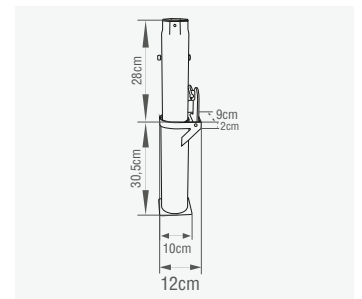

REF. 04030043

Base de embutir ao pavimento
In-floor base



Ø 58-78mm



7,6kg



3x3m | 4x4m
5x5m

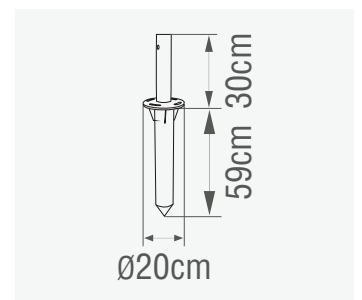

BASES METÁLICAS



REF. 04030065

Base de ferro
Iron base

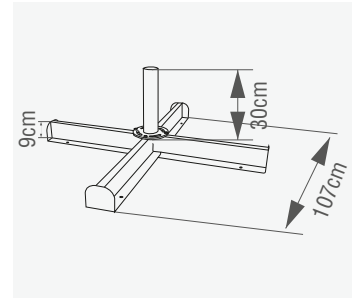
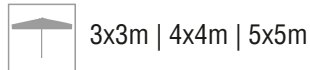

REF. 04030065.0001

Base de ferro com oito pedras em cimento britado
Iron base with eight crushed cement stones

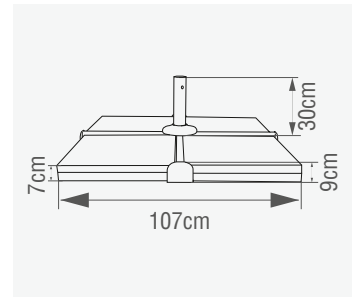
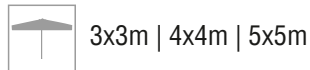
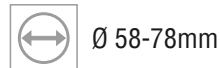

REF. 04030063

Base desmontável
Dismountable base

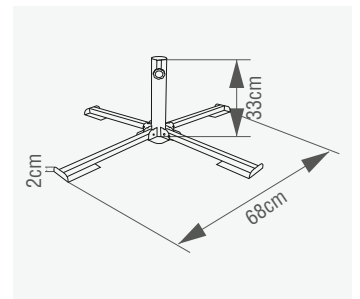
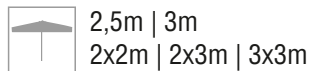
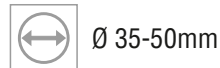

REF. 04030063.0001

Base desmontável com quatro pedras em cimento britado
Dismountable base with four crushed cement stones

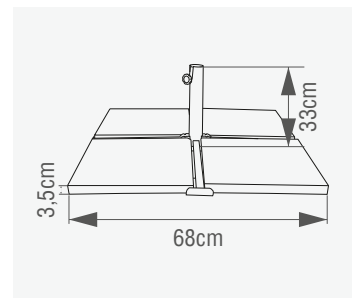
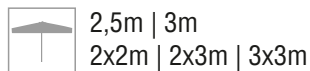
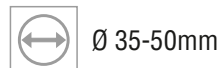

BASES METÁLICAS



REF. 04030065.0002

Base de ferro articulada com oito pedras em cimento britado
Articulated iron base with eight granite concrete stones



Ø 58-78mm



178kg



4x4m | 5x5m

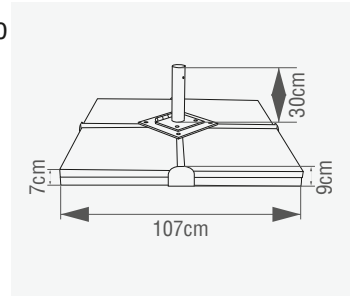

REF. 04030064

Base desmontável com parafusos
Dismountable base with screws



Ø 35-55mm



4kg



2m | 3m
2x2m | 2x3m | 3x3m

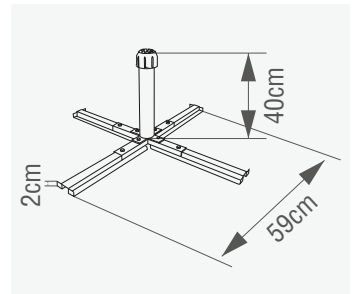

REF. 04030064.0001

Base desmontável com quatro pedras em cimento britado
Dismountable base with four crushed cement stones



Ø 35-55mm



58kg



2m | 3m
2x2m | 2x3m | 3x3m

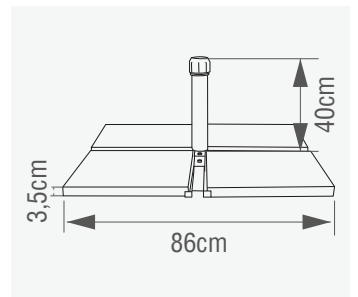

REF. 04030048

Base de ferro em cruz
Crossed iron base



Octogonal
60/64mm



10,6kg



Modelo Apple
Apple model

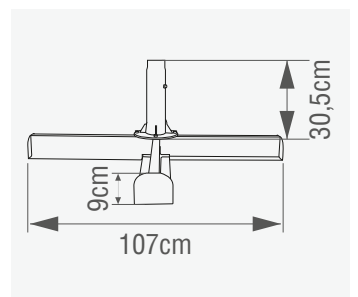

BASES METÁLICAS



REF. 04030048.0002

Base em cruz com oito pedras em cimento britado
Crossed base with eight crushed cement stones

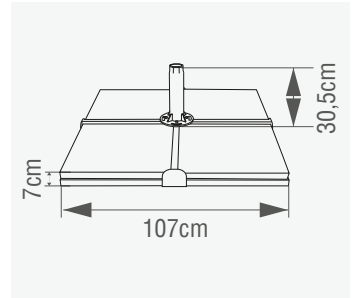

REF. 04030065.0008

Base de ferro
Iron base

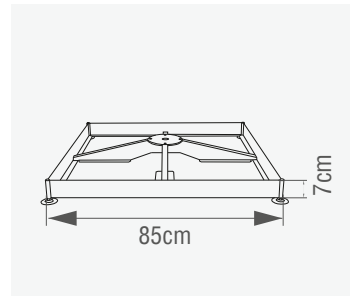
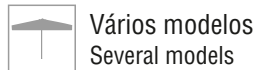

REF. 04030065.0009

Base de ferro com oito pedras em cimento britado
Iron base with eight crushed cement stones

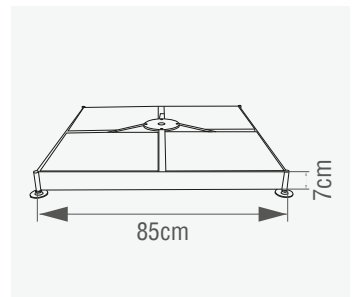
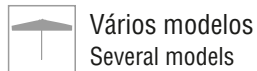

REF. 04030072

Base de ferro para fixar ao pavimento
Iron Base to fix on the floor

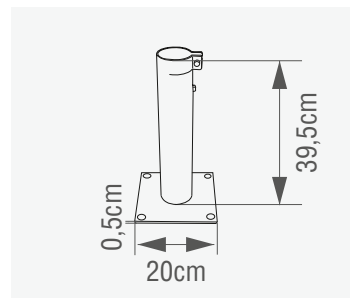
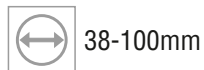

BASES METÁLICAS



REF. 04030027.0015

Base de ferro com tubo e cavilha de segurança
Iron base with safety dowel and tube

 Ø 35-50mm

 45kg

 3m | 2x3m
3x3m

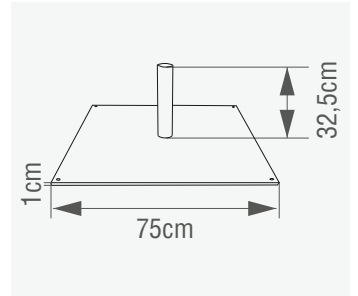

REF. 04030083

Base metálica lacada a branco
Metal base white coating

 Ø 50mm

 18kg

 2x2m | 2,5x2,5m
3x3m (fixa ao solo | fixed to the ground)

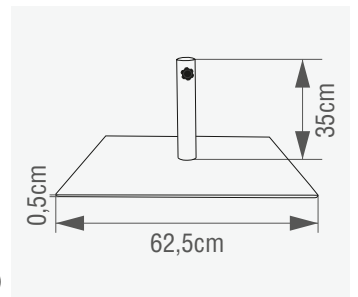

REF. 04030055.0011

Base metálica lacada a branco
Metal base white coating

 Ø 50mm

 16kg

 2x2m | 2,5x2,5m
3x3m (fixa ao solo | fixed to the ground)

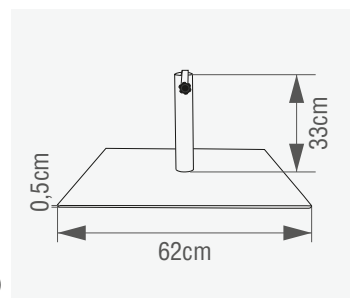

REF. 04030056.0008

Base metálica lacada a branco com cavilha
Metal base white coating with pin

 Ø 50mm

 21kg

 2x2m | 2,5x2,5m |
3x3m (fixa ao solo | fixed to the ground)

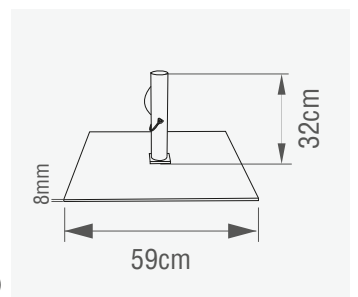

BASES PLÁSTICAS



REF. 04030086

Base em polietileno de alta densidade feita a partir de material reciclado

High-density polyethylene base made from recycled material



Ø 19-33mm



18kg
Cheia de água
Full of water



1,60m | 1,80m
2m

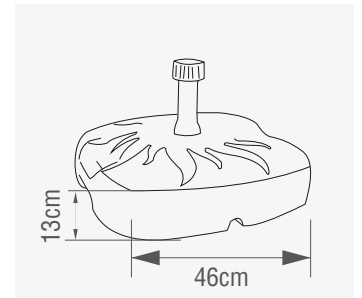

REF. 04030009.0005

Base em plástico

Plastic base



Ø 30-50mm



52kg
Cheia de água
Full of water



2x2m | 2x3m

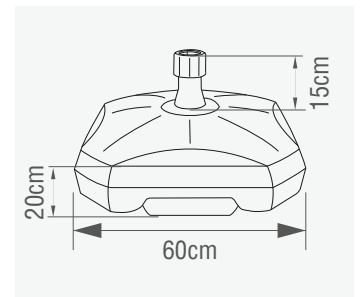

REF. 04030079

Base em cimento revestida a plástico

Cement base plastic coated



Ø 18-53mm



21kg



2m | 1,80m | 2,5m
2x2m

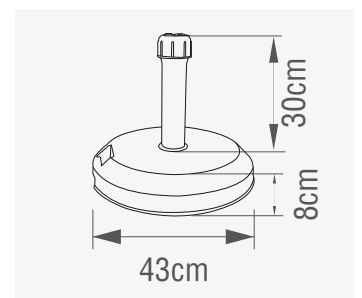

REF. 04030009.0007

Base de plástico preto com rodas

Black plastic base with wheels



120-160kg
Cheia de água
Full of water



Vários modelos
Several models

